

ACHTUNG: Tierspielzeug - nicht unzerstörbar! - Benutzung nur unter unmittelbarer Aufsicht von Erwachsenen! Nicht für Kinder geeignet! Gefahr des Verschluckens von Kleinteilen! Gefahr der Strangulation!

ATTENTION: Animal toy - not indestructible! Usage under direct supervision of adults only! Not suitable for children! Danger of swallowing small pieces! Danger of strangulation!

LET OP: Huisdier Speelgoed- niet onverwoestbaar! Gebruik alléén onder strikt toezicht van een volwassene! - Niet geschikt voor kinderen! - Gevaar voor inslikken van kleine onderdelen! Risico tot wurging!

ATTENTION: Jouet pour animal de compagnie - n'est pas indestructible! A utiliser sous la surveillance d'un adulte! - Ne convient pas aux enfants! Risque d'ingestion de petites pièces! Risque de strangulation!

ATTENZIONE: Giocattolo per animali - non è indistruttibile! Utilizzare sotto la diretta supervisione degli adulti! - Non adatto per bambini! Pericolo di ingestione di piccole parti! Pericolo di soffocamento!

ATENCIÓN: Juguete para animales - no es indestructible! Uso bajo supervisión directa de adultos! No es apto para niños! Peligro de ingestión de piezas pequeñas! - Peligro de asfixia!

PA0705805

Ref.No.

431-443835



EUROPET BERNINA INTERNATIONAL B.V.
P.O. Box 6 - 5420 AA Gemert-Bakel
The Netherlands
info@ebi.eu - www.ebi.eu

Part of



Crawford

Bauanleitung - Assembly instruction - Montage-instructies - Instructions de montage -
istruzioni di montaggio - Instrucción de montaje





1

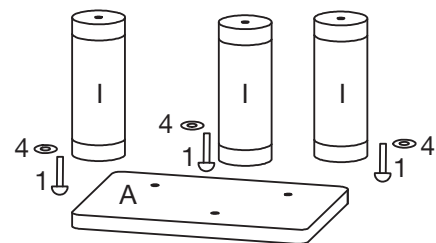

2

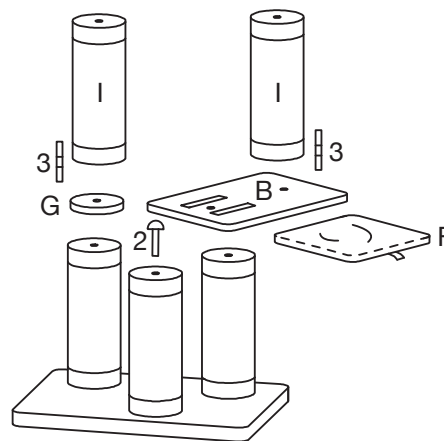

3

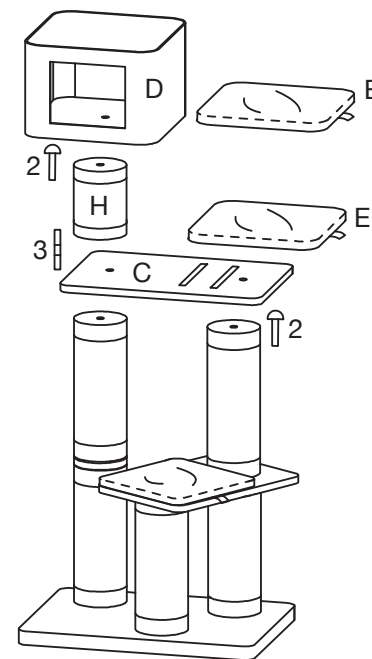

4

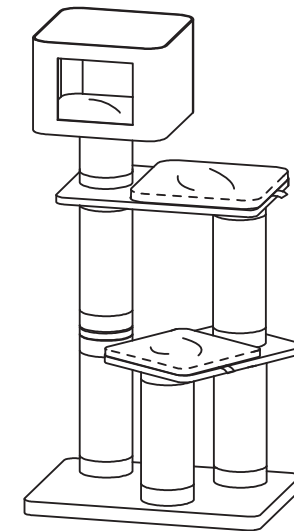

Teile / Delen / Pièces / Parts /
Parti / Piezas

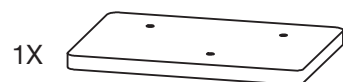

1X 70 x 50 x 4 cm (A)



1X 50 x 35 x 2 cm (B)

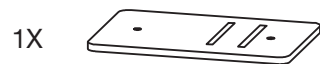

1X 60 x 40 x 2 cm (C)

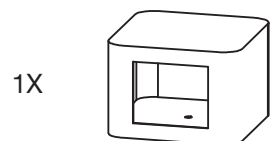

1X 40 x 40 x 27.5 cm (D)



2X 38 x 38 cm (E)



1X 30 x 30 cm (F)



1X Ø 15 x 2 cm (G)



1X Ø 15 x 20 cm (H)

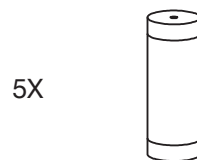

5X Ø 15 x 40 cm (I)

3X  Ø 10 x 60 mm (1)

3X  Ø 10 x 50 mm (2)

3X  Ø 10 x 70 mm (3)

3X  Ø 40 mm (4)

